

pourxOURA



Light-guided coffee scale manual

V.PX001.En—2021.03.24

Contents

Product	2	Product Introduction
	2	Appearance Introduction

Instruction	3	Applicable Environment
	3	Turn on/ Turn off
	3	Tare/Zero
	3	Unit Exchange
	3	Mode Exchange

Mode Introduction	4	Mode 1 【 Weighing Mode】
	5	Mode 2 【Pour Over Mode】
	6	Mode3 【Light-guided Mode】
	7	Comparison Table of Mode Functions

Product Maintenance	9	Battery Charging
	9	Weight Calibration
	9	Use Restriction

Setting	10	Setting
----------------	-----------	---------

Appendix	11	Button Instruction
	12	LED Light Instruction
	12	Error Code

Product Specification	13	Product Specification
------------------------------	-----------	-----------------------

Product

Product Introduction

Please check the contents in the box.

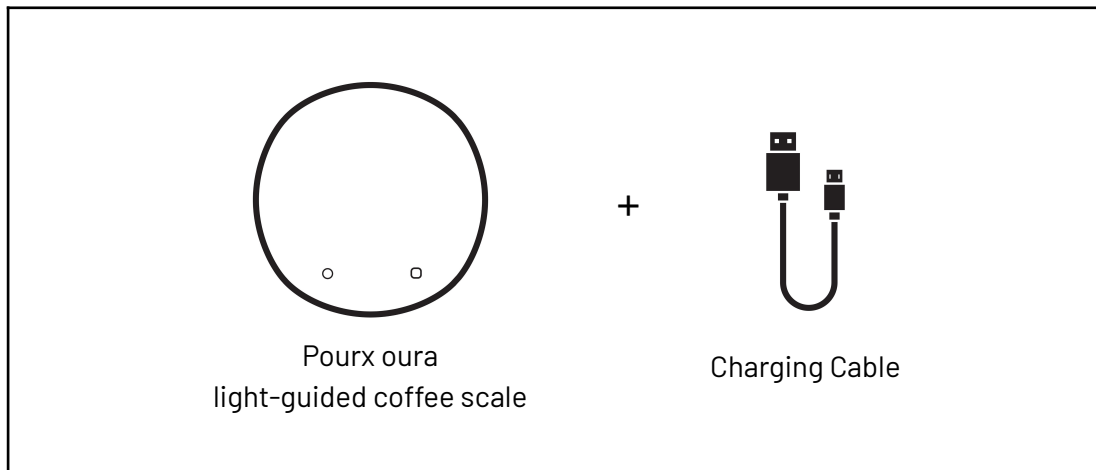

Appearance Introduction

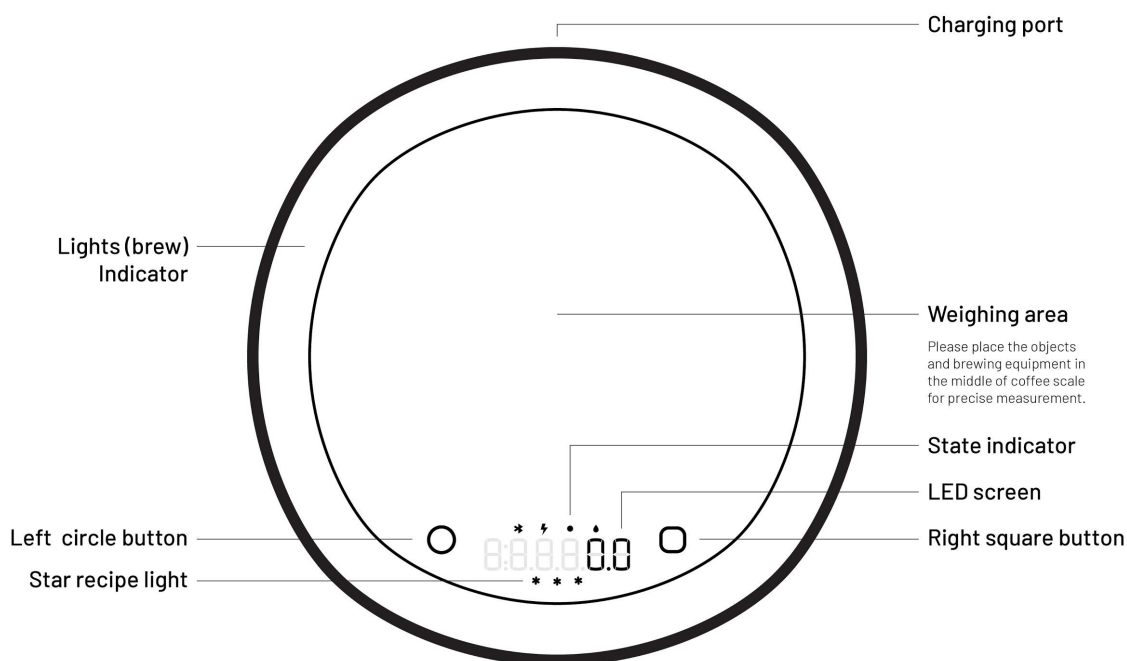

Please follow "Initial instruction" of the manual to start using your coffee scale. Please read the manual for the advanced functions and follow the instructions and examples for operating.

***Warning: Product may be damaged by any other reason, such as improper installation, failure to follow the operational instructions, and it is not covered by this warranty.**

Instruction

***Please charge 4 hours in the very first time.**

Applicable environment: Please use the product on a stable and vibration-free surface.

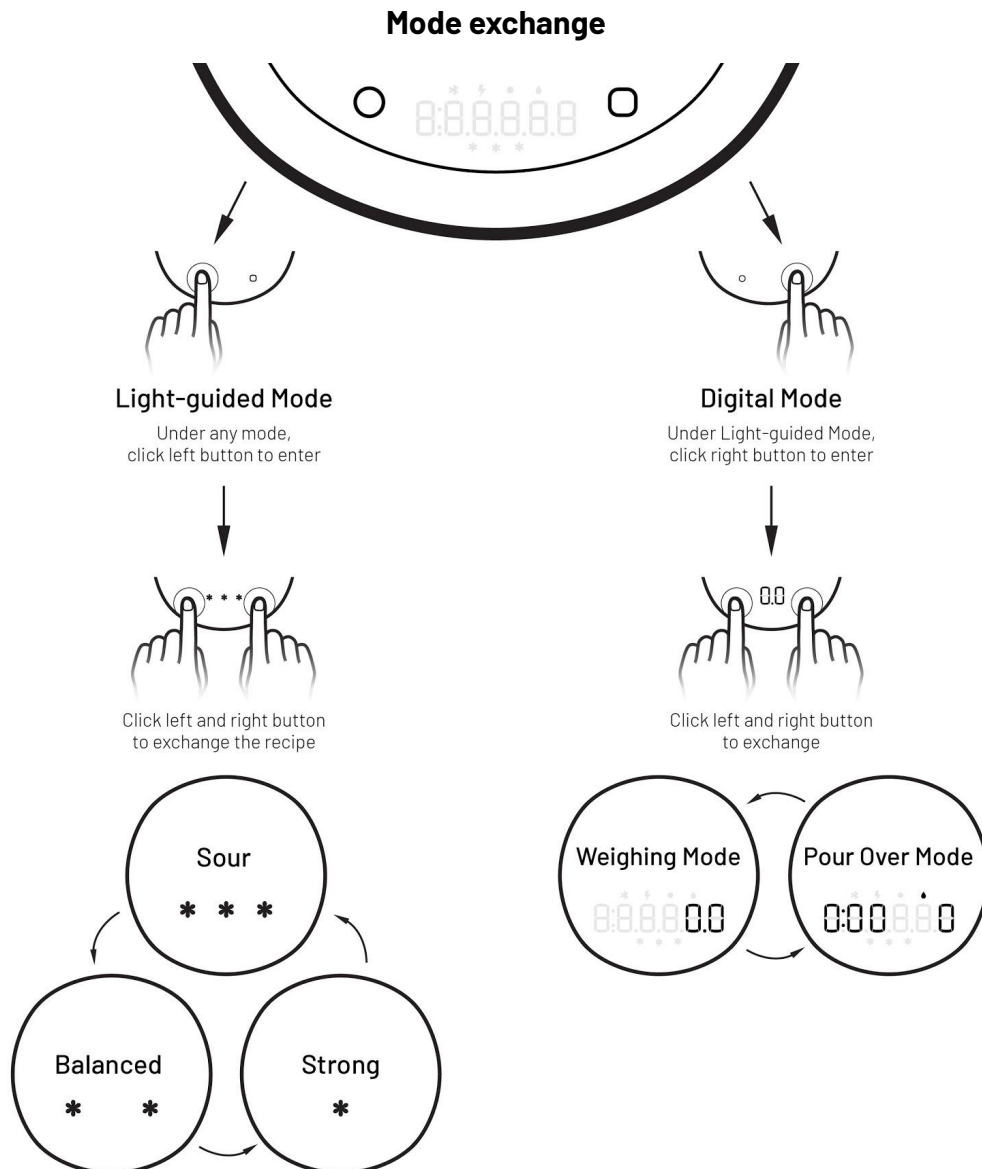
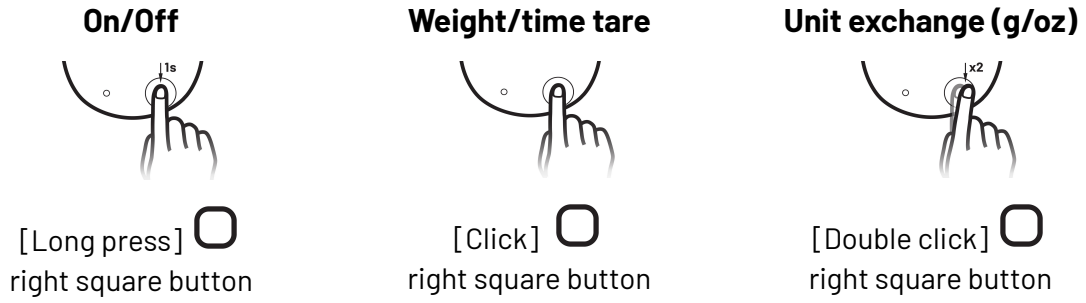

Mode Introduction

Mode 1 [Weighing Mode]

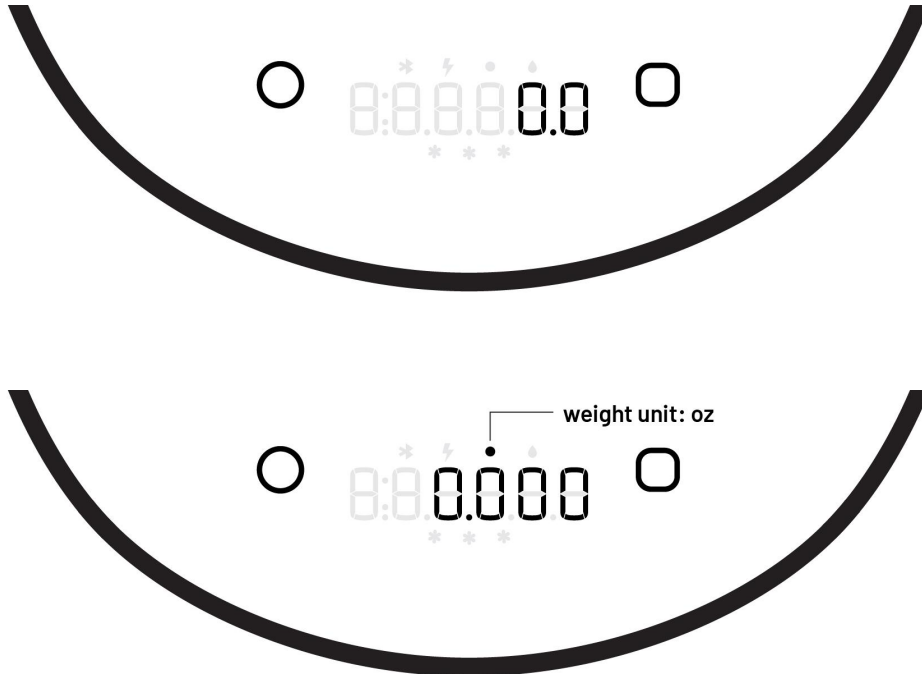

In Weighing Mode, product can precisely measure the objects from 0.1 to 2000g.

- Display **0.0**, means the unit as g.
- Display **0.000**, means the unit as oz.

Function Table of [Weighing Mode]

Function	Description of operation
Tare	[Click] <input type="checkbox"/> right square button to tare weight.
Unit exchange	[Double click] <input type="checkbox"/> right square button to exchange g/oz.
Mode exchange	[Click] <input type="checkbox"/> left circle button+ <input type="checkbox"/> right square button to exchange to Pour Over Mode.
	[Click] <input type="checkbox"/> left circle button to exchange to Light-guided Mode.

Mode 2 [Pour Over Mode]

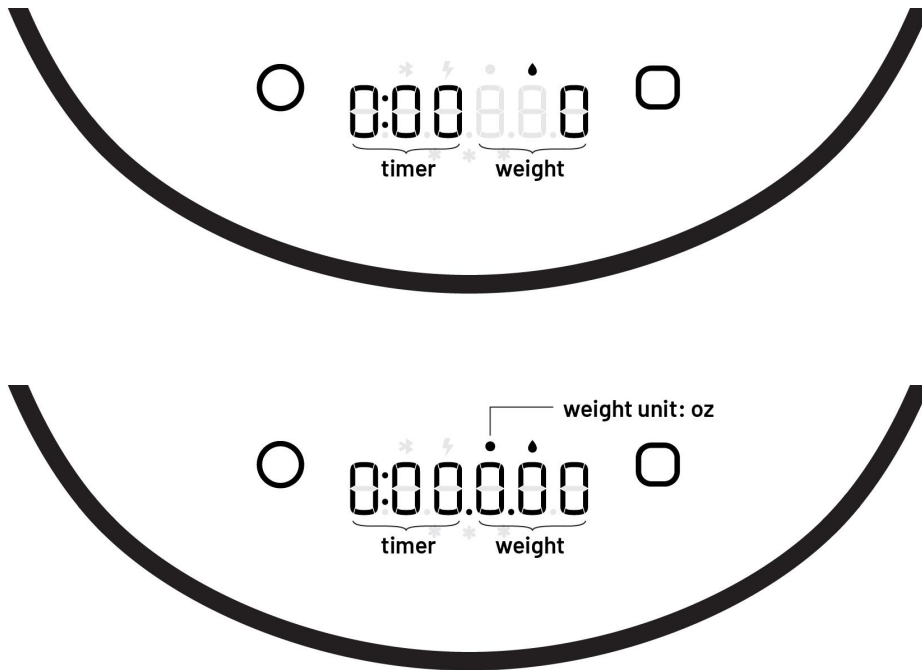

In Pour Over Mode, it will display timing and weight at the same time.

When the water is detected, the clock starts automatically.

When the weight is negative value or over 999g, it will display the weight as ---.

- Display **0:00 0**, means the unit as g.
- Display **0:00.0.00**, means the unit as oz.

Function Table of [Pour Over Mode]

Function	Description of operation
Tare	When timer didn't start, [Click] <input type="checkbox"/> right square button to tare weight.
Pause timer/ Reset time	When timer starts, [Click] <input type="checkbox"/> right square button to stop timer. After pause the timer, [Click] <input type="checkbox"/> right square button to tare weight and zero timer.
Unit exchange	[Double Click] <input type="checkbox"/> right square button to exchange g/oz.
Mode exchange	[Click] <input type="checkbox"/> left circle button+ <input type="checkbox"/> right square button to exchange to Weighing Mode.
	[Click] <input type="checkbox"/> left circle button to exchange to Light-guided Mode

Mode 3 [Light-guided Mode]

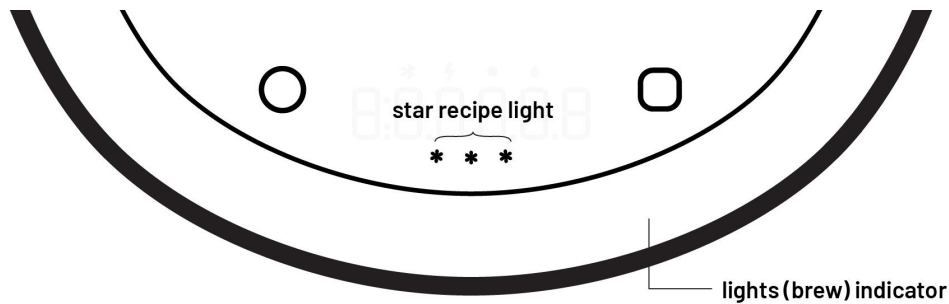

In Light-guided Mode, just follow the light change of lights (brew) indicator and execute every step of pour over, which includes pouring, stop and adjustment of flow rate, then you can easily complete a cup of stable quality coffee.

Default 3 recipes in oura, the star can correspond to the star recipe in APP:

- * * * Sour flavor: coffee beans 20g、grind degree #5, 92°C、300ml hot water
 - * * Balanced flavor: coffee beans 20g、grind degree #5, 92°C、300ml hot water
 - * Strong body: coffee beans 20g、grind degree#4, 92°C、300ml hot water
- Tip: [Click] ○ left circle button+○ right square button to exchange the recipes.

Off Line Brewing Process:

1. Prepare 20g grinded coffee powder. For the grind degree, please refer to the grinding tips under the product.
2. Place jug, dripper, coffee paper filter and coffee powder on the coffee scale.
3. [Click] ○ left circle button to enter Light-guided Mode, and the lights indicator will bright white light from both sides.
 - 4. When re-place the equipment on the coffee scale, Light-guided Mode will be restarted automatically.
4. After pour, the lights indicator will become to **green light**, please keep pouring and stop when it turns into **red light**.
 - When the first step pouring, coffee scale doesn't prompt for the flow rate.
 - Before light color change, countdown tone will ring.
5. Wait for red light turning into **green light**, and pour the water until the lights indicator turns into **red light**.
 - Spin **green light**: moderate flow rate
 - Flash **green light**: to enlarge the flow rate
 - Breath **green light**: to slow down the flow rate
6. When the lights indicator is in bright **white light**, it means you complete brewing.

Function Table of [Light-guided Mode]

Function	Description of operation
Restart the Light-guided Mode	In Light-guided Mode, [Click] <input type="radio"/> left circle button to tare weight and zero the timer.
Recipes exchange	[Click] <input type="radio"/> left circle button+ <input type="radio"/> right square button to exchange the 3 default recipes.
Mode exchange	[Click] <input type="radio"/> right square button to exchange Weighing Mode and Pour Over Mode.

Comparison Table of Mode Functions



Light-guided Mode



Weighing Mode



Pour Over Mode

Measure unit	<input type="radio"/>	<input type="radio"/>	<input type="radio"/>
Automatically tare	<input type="radio"/>	×	×
Automatically count down	<input type="radio"/>	×	<input type="radio"/>
Light-guiding	<input type="radio"/>	×	×
Weight display	Can open on APP	<input type="radio"/>	<input type="radio"/>
Timer mode	×	×	<input type="radio"/>



www.pourxlab.com/applist

Download Pourx App for The Advanced Functions

More personal setting, please refer 「Setting」



Download recipes

From recipes database via APP or scan the Pourx QR Code on the coffee pouch to download the brewing recipes and more details. Choose [Add recipes] > [scan QR code], to scan and download.

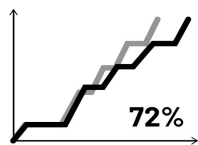

Connect to compare the brewing

On-line to choose recipe and click [start brewing], follow the instruction in APP to brew, and can compare them then.

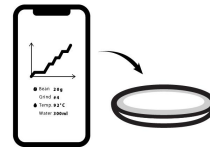

Change the default recipes in coffee scale

Turn on Wifi and connect, then long press the recipe and drag to the area of star recipes. The recipes will synchronize to coffee scales in 10 seconds.

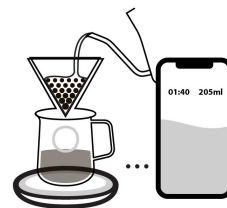

Record personal recipe

On-line to choose [add recipe], and [create recipe] to set the weight of coffee bean, then click [next step], and [start brewing] to start brewing.

Product Maintenance

Battery Charge

- Adapt 5V1A transformer to charge
- Will take about 4 hours to full charge
- Suggest charging battery when charge light flashes.
- Under full charge and the lightest halo, the product can operate light-guided brewing for 8 hours.

***Attention: 「Quick charge」(1A power supply and output over 5V) may damage the circuit board of coffee scale.**

Weight Calibration

1. Prepare standard 100g weight and download Pourx app.
2. Connect via Bluetooth and enter [Setting].
3. Choose [Bluetooth and hardware setting] and click [calibration mode].
4. Then follow the instruction in APP to calibrate weight.

***Attention: When calibrate the weight, please don't plug the charging cable. It may cause the inaccurate calibration.**

Use Restriction

- Do not expose or store the product in improper environments, such as high temperature, high humidity, or near the magnetic objects.
- Don't weight the heavy objects over 2 kg. Don't press and drop the product. Don't soak or wash the product in the water.
- When not in use, please store it flat, and don't place the objects on the scale for a long time.

Setting









www.pourxlab.com/applist

Download Pourx app, turn on Bluetooth to connect, and enter [Setting], then choose [Bluetooth and hardware setting] to set up in APP.

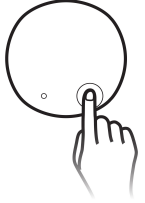
Setting menu	Options
Automatic connecting	<ul style="list-style-type: none"> ● ON: Open APP to search coffee scale automatically. ● OFF: Connect coffee scale manually.
Automatically power off	<p>Set up the time period which weight is not change, after the time, the product will turn off automatically.</p> <ul style="list-style-type: none"> ● 3 mins: OFF -- 3 ● 5 mins (default): OFF -- 5 ● 10 mins: OFF - 10 ● 15 mins: OFF - 15 ● OFF: Product is not going to turn off until run out the battery.
Volume of coffee scale	<ul style="list-style-type: none"> ● 5 degree: - - - - - ● 4 degree (default): - - - - ● 3 degree: - - - ● 2 degree: - - ● 1 degree: - ● Mute: no display
Brightness of coffee scale	<ul style="list-style-type: none"> ● Can set up 6 degrees of brightness, it can show the brightness of halo in Light-guided Mode.
Weight display in Light-guided Mode	<ul style="list-style-type: none"> ● ON: display 0.1g in Light-guided Mode. ● OFF(default): no display any digitals in Light-guided Mode.
Tolerance of brewing guiding	<ul style="list-style-type: none"> ● General (Default): EASY ● Professional: Pro, coffee scale will sensitively prompt the flow rate in Light-guided Mode, and it will help the brewing curve to close to the target curve.

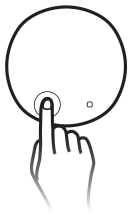

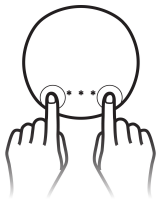

Appendix

Button Description

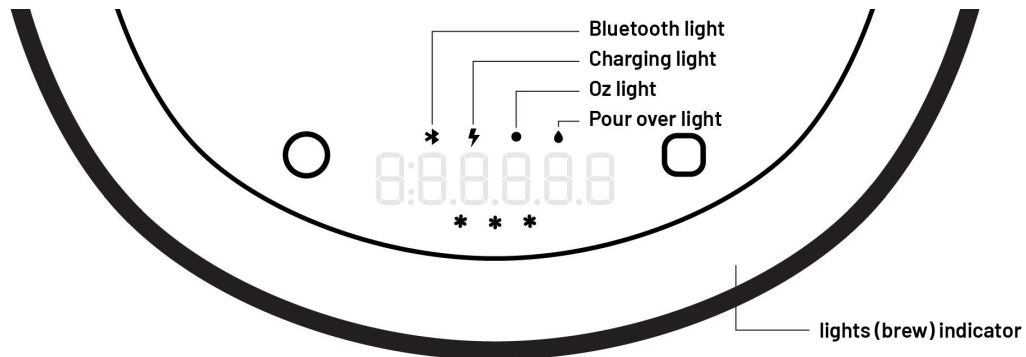
Button	Function	Description of operation
  Right square button	Turn on	Long press 1 second to turn on, and enter Weighing Mode and Pour Over Mode.
	Turn off	Long press 1 second to turn off.
	Mode exchange	In Light-guided Mode, click to exchange to Weighing Mode and Pour Over Mode.
	Tare	In Weighing Mode, click it to tare weight.
		In Pour Over Mode and timer doesn't start, click to tare weight.
	Pause time/ reset timer	In Pour Over Mode and timer starts, click to pause the timer. Click it again to tare weight and zero the timer.
Unit exchange	In Weighing Mode and Pour Over Mode, double click to exchange g/oz.	
  Left circle button	Turn on	Long press 1 second to turn on and enter Light-guided Mode.
	Turn off	Long press 1 second to turn off.
	Mode exchange	In Weighing Mode and Pour Over Mode, click to enter Light-guided Mode.
	Restart light guiding	In Light-guided Mode, click to tare weight and zero the timer.
	Restart	Long press 5 seconds to restart. (when product is shut down)
  Both button	Mode exchange	In Weighing Mode, click both buttons to exchange to Pour Over Mode.
		In Pour Over Mode, click both buttons to exchange to Weighing Mode
	Recipe exchange	In Light-guided mode, click both buttons, exchange 3 recipes.

LED Light Instruction

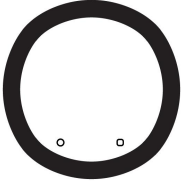

Light	Description
 Bluetooth light	Light on: connected to the mobile phone
 Charge light	Light flash: low power, please charge Light is on: charging (Light will be off when full charge)
 Oz light	Light on: the measure unit is oz.
 Pour over light	Light on: Pour Over Mode
 Lights (brew) indicator	<ul style="list-style-type: none"> • White light: prepare to start or brewing finish • Spin green light: moderate flow rate • Flash green light: to enlarge the flow rate • Breath green light: to slow down the flow rate • Red light: stop pouring and wait • Purple light: stir powder • Breath white light: on-line to record the recipe

Error Code

When LED screen displays "- - - - -", means over the measurement range.

Product Specification

Product name	Pourx oura
Product weight	375 g
Product dimension	15cm (L) / 15cm (W) / 2.1cm (H)
Max weighing value	2000 g
Min weighing value	0.1 g
Measurement unit	g / oz
Max display value	2050 g
Charing power	Charge current: 5V / 1A
Battery	USB rechargeable lithium battery 3.7V / 1750mAh
Battery stand by time	Stand by 145 hours / operation 8 hours
Display screen	LED display
Water repellent	YES
Material	Metal, plastic, silicon
Wireless device	Bluetooth 5.0
Product warranty	1 year
Contents	Pourx oura light-guided coffee scale x1, Micro USB charging cable x1

Copyright Notice

All contents used in this manual are protected by copyright law, trademark law, patent law and other intellectual property rights. Without legal authorization, please do not reproduce, modify, distribute or other illegal use. ©2020 Abilliant Corporation.